

Comittente: **Comune di Subiaco**
 Piazza S. Andrea, 1 - 00028 Subiaco (RM)
 tel. 0774 8161 - fax 0774 822310
 sito web: www.comune-subiaco.rm.it
 e-mail: info@comunesubiaco.com

Città metropolitana di Roma Capitale

Oggetto lavori: **ADEGUAMENTO STATICO SISMICO, ENERGETICO E FUNZIONALE PLESSO SCOLASTICO VIA FOGGAZARO, 3**



DATA: Settembre 2020

AGG. **1**

SCALA: Varie









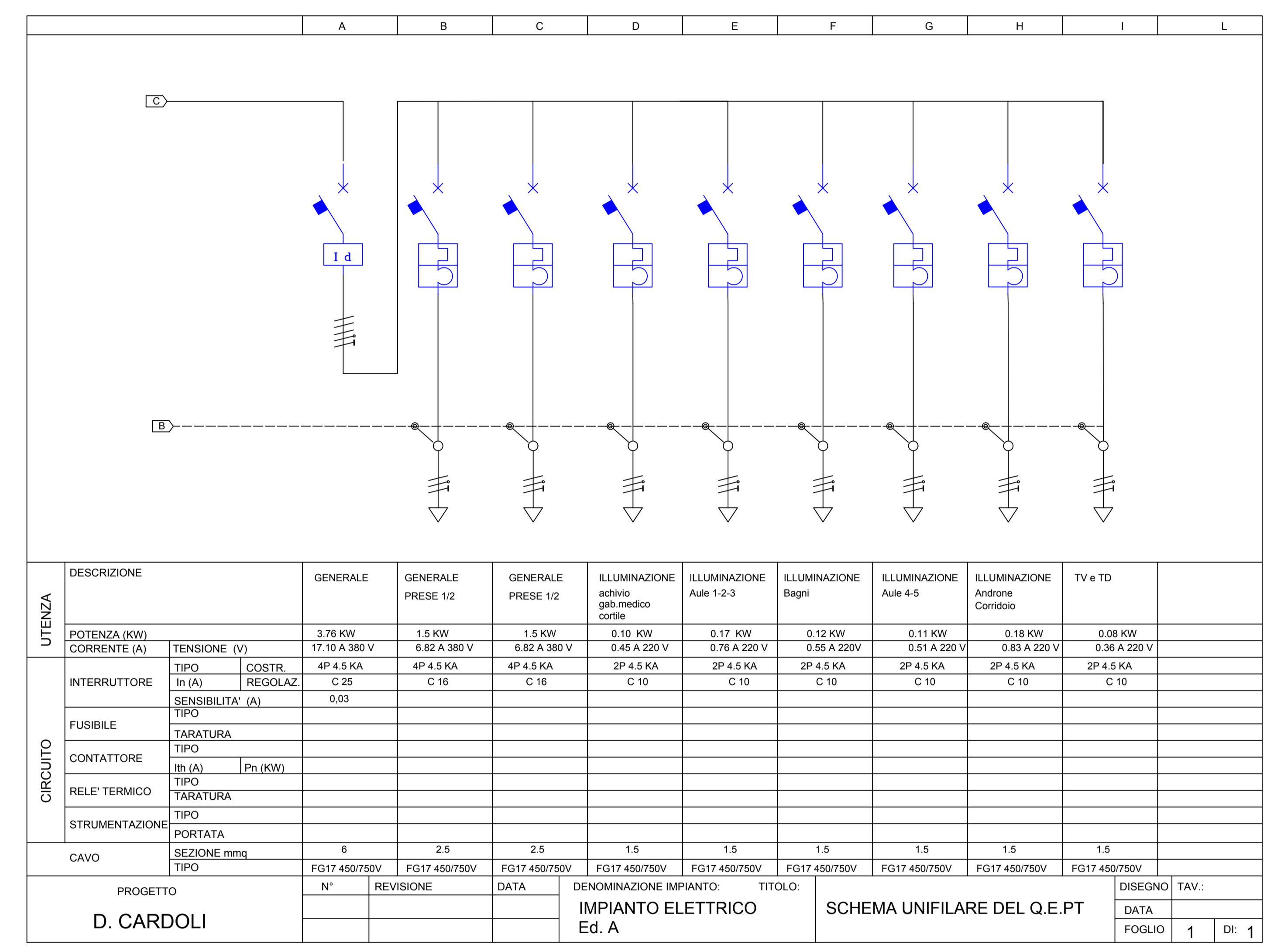
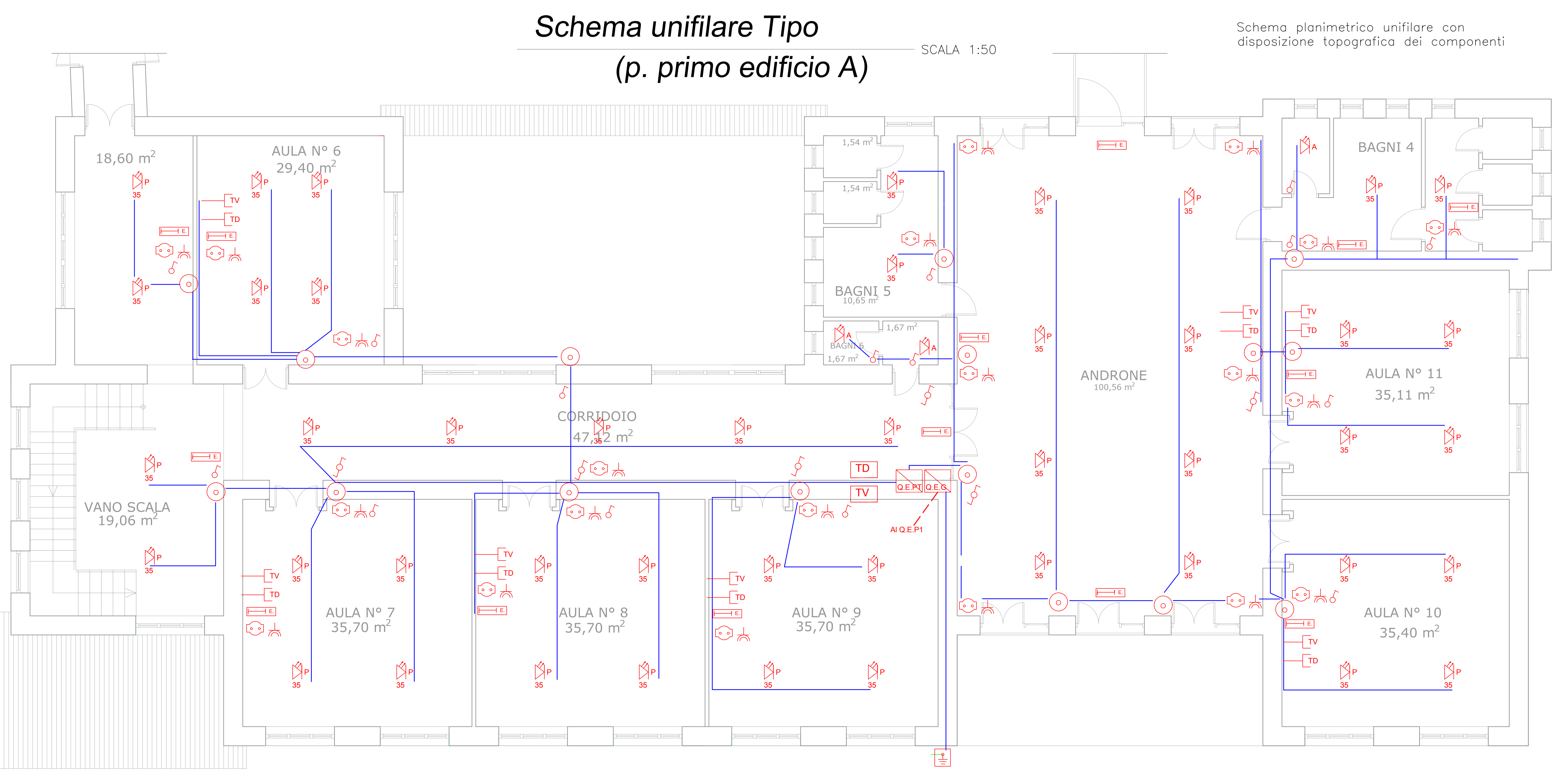
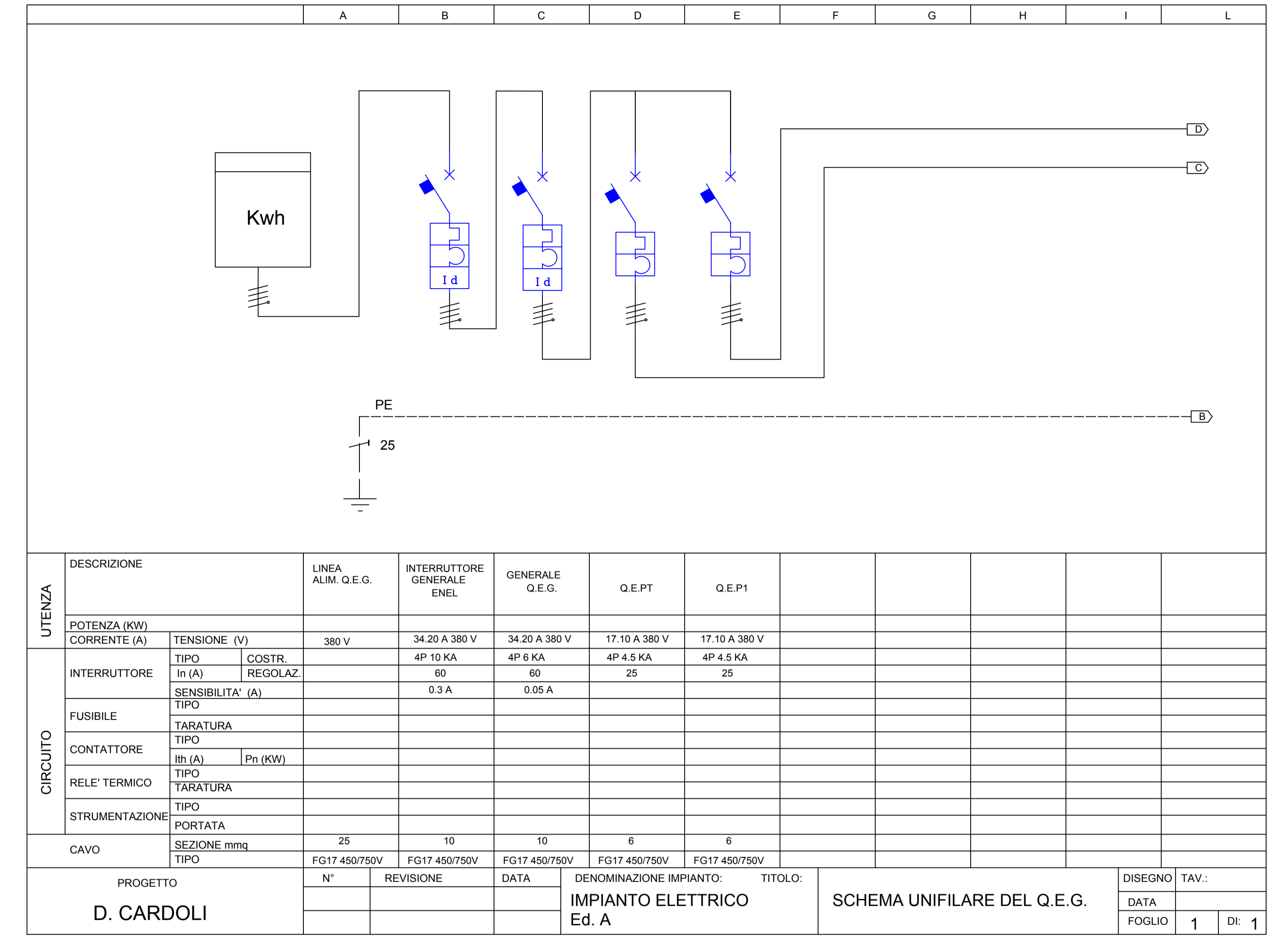
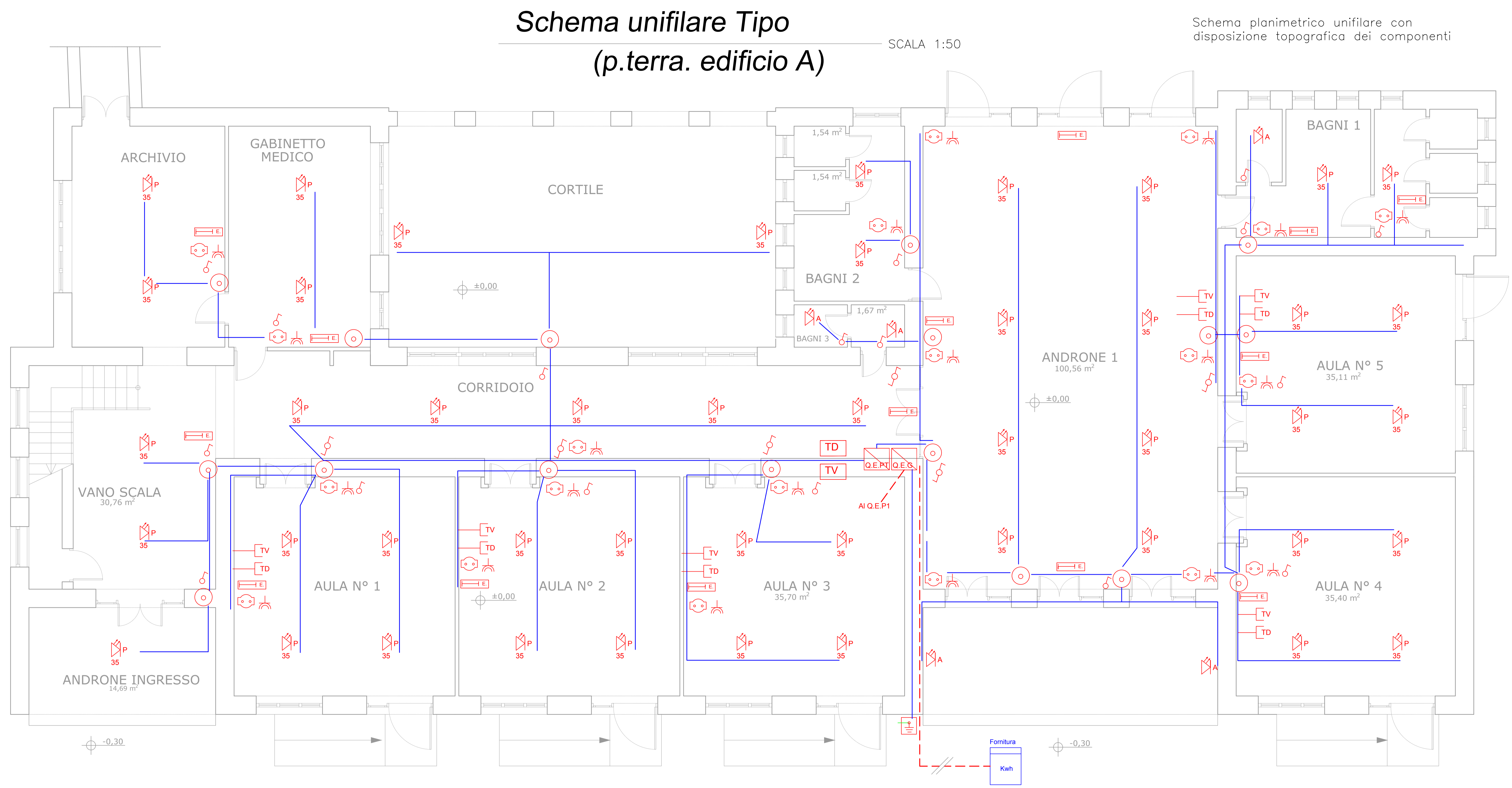



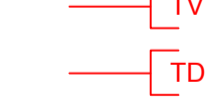

PROGETTO DEFINITIVO

ELABORATO **11.0**

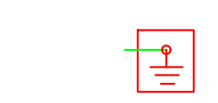
Progettista: Arch. Daniele Cardoli

Supporto: Ing. Vincenzo Pitta



- #### LEGENDA
-  Quadro elettrico generale
 -  Scatola di derivazione
 -  Presa antenna TV
 -  Trasmissione dati
 -  Centralina TD e telefonica
 -  Centralina TV
 -  Conduttura murata tubazione corrugata PVC Ø min 20
 -  Applique a Led 12 W
 -  Plafoniera a Led 35 W
 -  Lampada di emergenza autonoma 20W led a doppio isolamento IP 54
 -  Pozzetto con palina in rame di messa a terra
 -  Presa bipasso 10/16 A. 220 V , 2P + N
 -  Presa Siemens 16 A. 220 V , 2P + N
 -  Interruttore unipolare
 -  Deviatore unipolare

